

Transportsystems



ELOORAC

THE EASY WAY FOR ECONOMIC TRANSPORTS

19/20



powered by:



Bundesministerium
für Wirtschaft
und Energie

Eloorac ist ein flexibles und effektives Transportsystem welches aus wenigen Teilen individuell zusammenstellbar ist. Als Basis dient in erster Linie die weit verbreitete Europalette.

Eloorac is a flexible and effective transport system which can be individually composed of less parts. The base is primarily the widely spread Euro pallet.

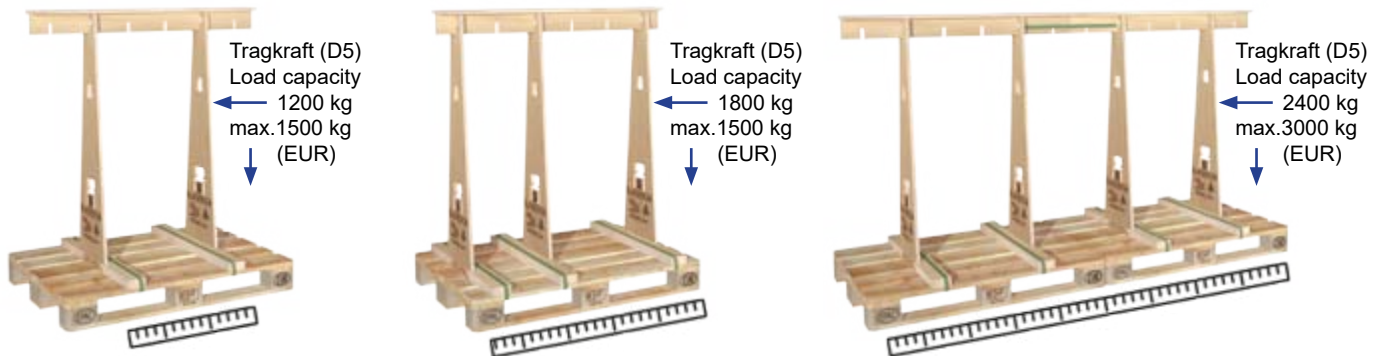

Durch die geschlitzten Querleisten besteht die Möglichkeit weitere aufrechte Wangenteile einzusetzen. Mit jedem zusätzlichen A-Teil erhöht sich automatisch die Gewichtsklasse des Gestells.

Due to the slit crossbars, it is possible to use further upright A-parts. Each additional A-part automatically increases the weight class of the rack.

Schnelle Montage
Quick assembly

Getestete Befestigung mit PET Band:
Beim Zusammenbau eines Eloorac´s kommen lediglich Befestigungsmittel zum Einsatz, die in der Regel auch zum Sichern der Ware genutzt werden.

Tested fastening with PET strapping:
Assembling an Eloorac only fasteners are used, which are typically utilized to secure goods.



Alternative Befestigung (nicht getestet):
Durch Verwenden einer Schraube und einem Flacheisen mit Gewindelochung wird das Eloorac Gestell auf der Palette festgeklemmt.

Alternative fastening (not tested):
By using a screw and a flat iron with threaded holes, the Eloorac rack is clamped on the pallet.



Platzsparend
Space-saving



Generell benötigen zerlegte Eloorac´s sehr wenig Lagerfläche. Nach Gebrauch wird das Eloorac von der Palette gelöst und einfach wieder platzsparend gestapelt.

In general, disassembled Eloorac require very less storage space. After use, the Eloorac is removed from the pallet and simply stacked again to save space.

70 fertige Gestelle
70 finished racks



Ein System, viele Längen

One system, many lengths



Zerlegte Eloorac Gestelle auf Europaletten aufgepackt.

Demounted Eloorac racks packed on Euro pallets.



Möglichkeiten Paletten miteinander zu verbinden.

Possibilities to connect pallets with each other.



Querleisten mit PET Band verbinden.

Connect crossbars with PET tape.

Eloorac Stabilität

Eloorac stability



Eloorac´s sind in einer Richtung recht beweglich. Sobald das zu transportierende Produkt auf dem Gestell befestigt ist, erhält man ein stabiles „Paket“.

Eloorac´s are quite moveable in one direction. As soon as the product to be transported is fixed to the rack, you get a stable „package“.



Alternativ kann eine Stabilisierungsplatte verwendet werden. Diese wird zwischen 2 aufrechten Wangenteilen befestigt.

Alternatively, a stabilization plate can be used. This is fixed between 2 upright A-parts.

Lange Paletten anheben

Lifting long pallets



Das Anheben langer Paletten mit dem Stapler, ist mit Eloorac Transport Systemen kein Problem. Sobald die Ware an der Palette befestigt ist, hat man ein „Paket“ geschnürt, welches sich nicht durchbiegen kann.

Lifting long pallets with a forklift is no problem with Eloorac transport systems. As soon as the goods are attached to the pallet, you have tied a „package“ which cannot bend.

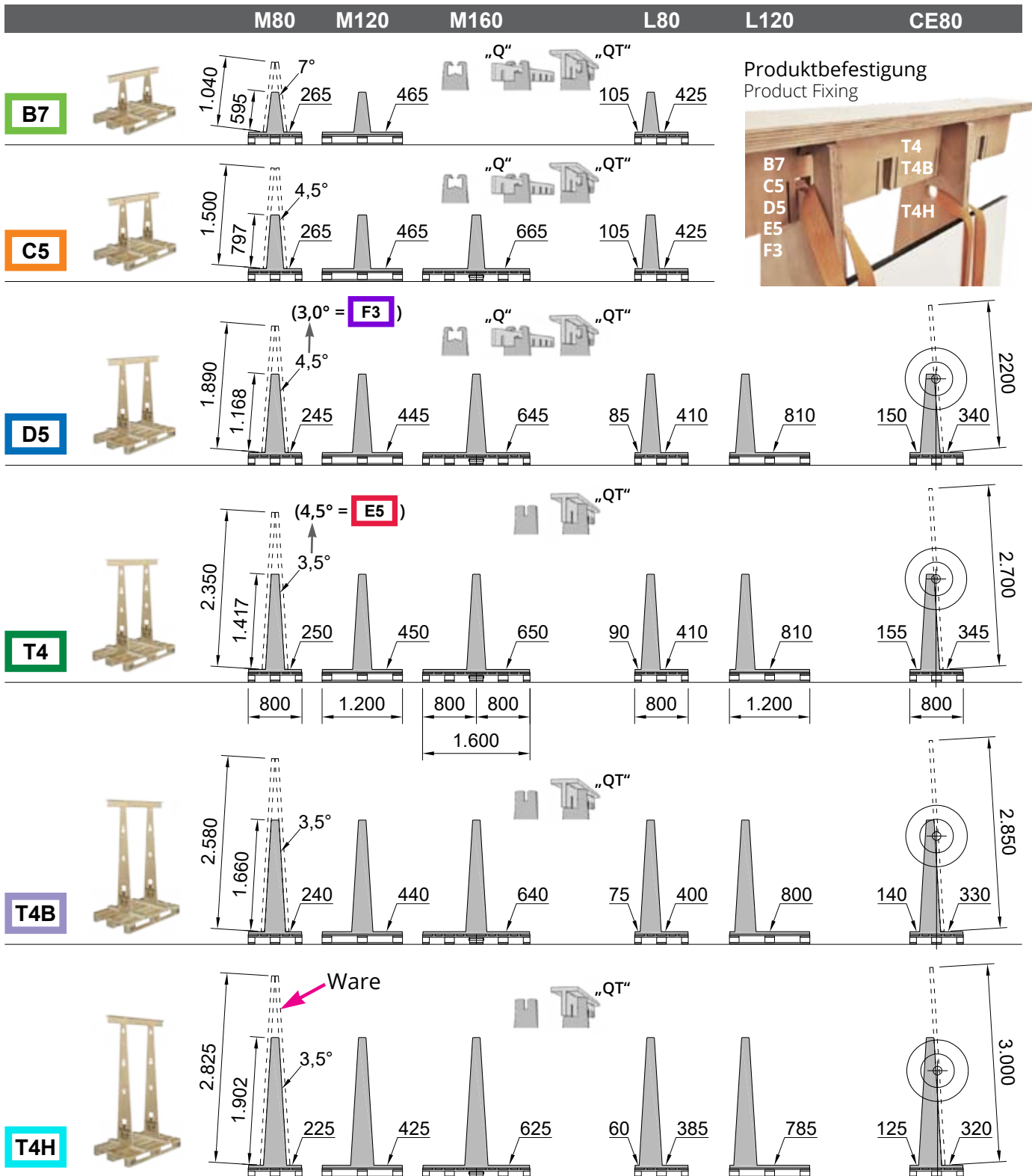

Produktbefestigung
Product Fixing



Weitere Modelle
Further models

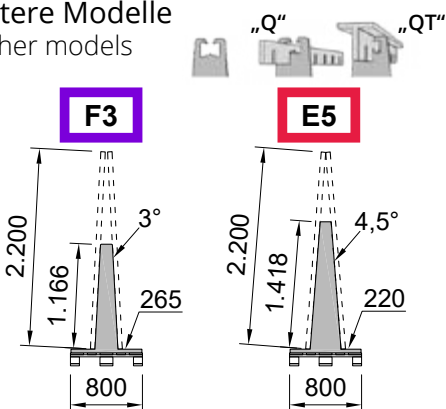

Erklärung der Modellbezeichnungen

Linke Seite: Alphabetische Benennung der Modelle. Die Zahl hinter den Buchstaben ist die gerundete Gradzahl des jeweiligen Anlagewinkels.

Oben quer: Die Buchstaben stehen für die Anordnung der aufrechten Wangenteile. „M“ = MITTIG, „L“ = L-Form, „CE“ = CENTRUM.

Die Zahl hinter dem „M“, „L“ und „CE“ gibt die Länge der unteren Kufe an.

Description of the model types

Left-hand side: The models are named alphabetically. The value behind the letter indicates the rounded degree of the inclination angles.

Above crosswise: The arrangement of the A-parts is marked by letters. „M“ = centered, „L“ = L-form, „CE“ = centre.

The number after „M“, „L“ and „CE“ indicates the length of the lower runner.

So wird bestellt
How to order

Beispiel / Example
1 Set: D5-M80-QT120

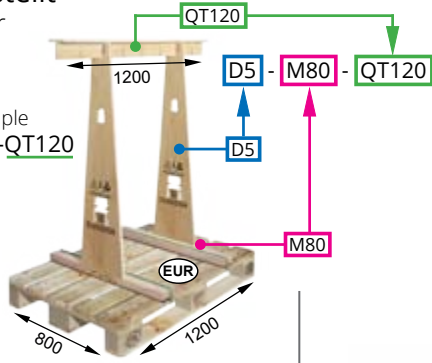

Kufenform
Bottom runners form

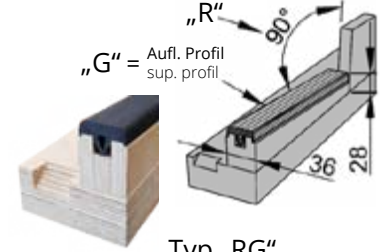
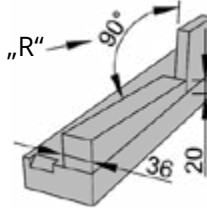
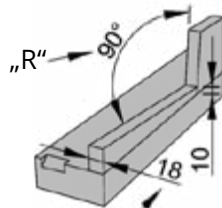
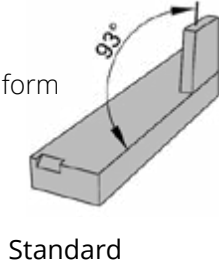

Standard

Nur bei „M80“
Only at „M80“

Typ „R“

Typ „RG“

Querleisten-Typen
Crossbar types

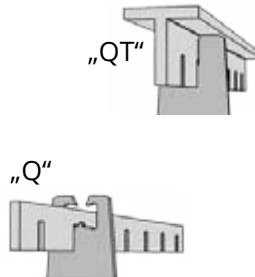
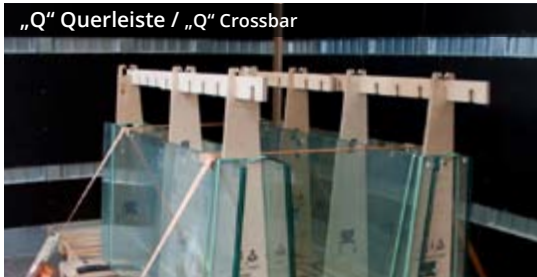

Querleisten Längen
Crossbar lengths

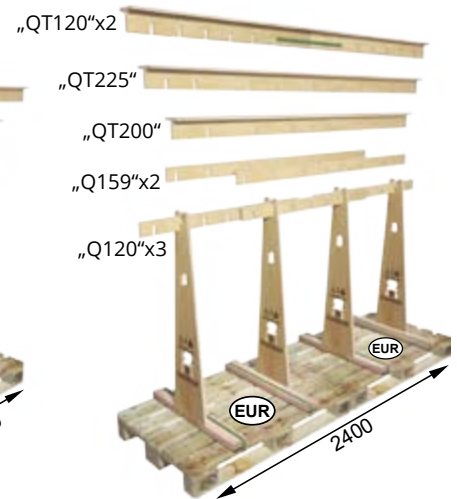
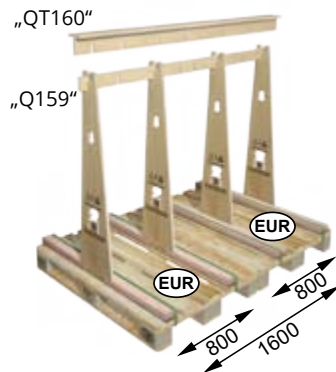

Kufenlängen
Runners length

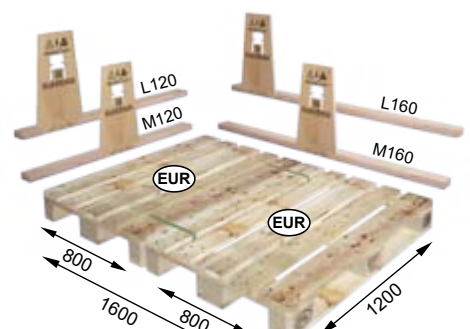
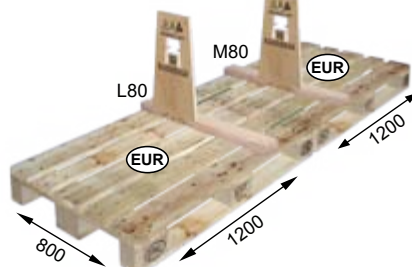
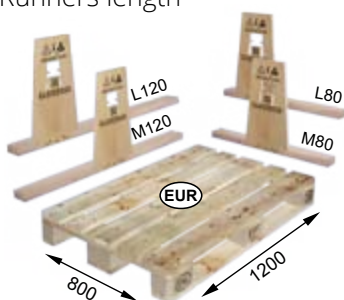

Rückholung
Retrieval



1. Auf der Baustelle zerlegte Eloorac´s können platzsparend im Montagewagen verstaut werden.
2. In der Werkstatt werden die einzelnen Eloorac Teile für den Rücktransport zum Lieferanten vorbereitet.
3. + 4. Wenn mehrere Aufträge abgearbeitet sind, können sämtliche Eloorac Gestelle auf einmal an einem Ort zur Wiederverwendung beim Lieferanten abgeholt werden. Das Anfahren einzelner Baustellen entfällt.

1. Eloorac´s disassembled on the construction site can be stowed in the installation truck to save space.
2. In the workshop the single Eloorac parts are prepared for return transport to the supplier.
3. + 4. If several orders have been processed, all Eloorac A-racks can be collected at one time from the supplier for reuse. There is no need to drive to single construction sites.



Links: Ausgelieferte Ware. Sobald die Gestelle entpackt sind, werden diese zerlegt, gestapelt und platzsparend zurück zum Hersteller transportiert. Auf diese Weise wurden viele Eloorac´s schon X-mal wiederverwendet.

Left: Delivered goods. As soon as the A-racks are unpacked, they are dismantled, stacked and transported in a space saving manner back to the manufacturer. In this way, many of the Eloorac´s have already been reused X times.

Einzelne Eloorac Gestelle können auch per Karton zurück geholt werden. Einfach einen passenden Karton bei der Auslieferung beilegen und anschließend abholen lassen. Auf diese Weise versenden wir unsere Eloorac´s weltweit.

Individual Eloorac racks can also be retrieved per cardboard box. Simply enclose a suitable carton with the delivery and arrange for it to be picked up afterwards. In this way we ship our Eloorac´s worldwide.

Kennzeichnung
Marking



Durch Barcodes oder Nummerierungen kann jedes Gestell einem Auftrag zugeordnet werden. Ein aufgedrucktes Logo mit Hinweis auf Eigentum ist auch aus Werbegründen sinnvoll.

Through barcodes or numerations, each rack can be assigned to an order. A printed logo as reference of possession is also useful for promotional reasons.

Platzsparend stapeln

Space-saving stacking



230 zerlegte Transportgestelle. Gesamte Tragkraft bei diesem Modell: **345.000 kg**

Eloorac Gestelle, die wie hier gestapelt werden, sparen im Gegensatz zu anderen Gestellsystemen enorm viel Platz bzw. Lagerfläche. Da es sehr einfach ist die Gestell-Stapel vom Kunden oder der Baustelle zurück zu holen, macht es natürlich auch Sinn diese immer wieder einzusetzen.

230 dismantled transport racks. Total load capacity on this modell: **760.595 lbs**

Eloorac racks, which are stacked like this, save a lot of space and storage space compared to other rack systems. Due to the fact that it is very easy to pick up the pallet with the stacked racks from the customer or the construction site, it makes sense to use them again and again.

Nachhaltigkeit - Warum Eloorac´s verwenden?

Sustainability - Why to use Eloorac´s?

Ziel: Transportsysteme sollten wiederverwendet und CO² sparend zurück geführt werden.

Target: Transport systems should be reused and be returned CO² saving.



Holzgestelle die nur EIN EINZIGES Mal verwendet wurden. Der belieferte Händler muß sich nun um die Entsorgung kümmern.

Wooden racks that have only been used ONE SINGLE time. The retailer now has to take care of the disposal.



Die Rückführung von Metallgestellen läßt Kosten durch Leerfahrten (Maut, Personal, Diesel, Abnutzung, Stauzeiten...) entstehen. Ausserdem wird durch den unnötigen CO² Ausstoß die Umwelt zusätzlich belastet.

The return of metal racks causes costs due to empty runs (toll, manpower, diesel, wear, congestion...). In addition the environment is additionally burdened by the unnecessary CO² emission.

Befestigungsbeispiele
Fastening examples

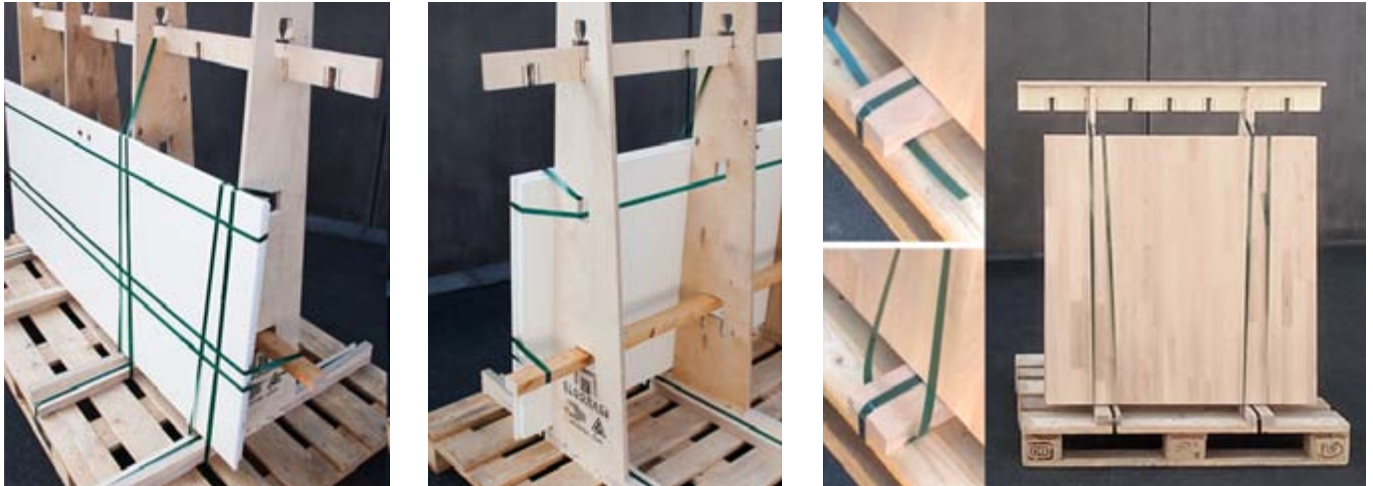

Produkte können auf verschiedene Art und Weise am Eloorac befestigt werden.
Products can be attached to the Eloorac in various ways.

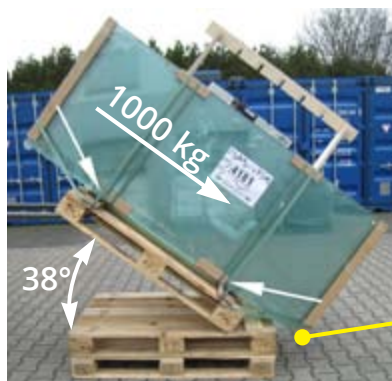

Dieser Test simuliert eine Vollbremsung. Dabei verrutschte die 1000 kg schwere Ware um lediglich 3 mm.
This test simulates a full braking. The 1000 kg heavy load has slipped by only 3 mm.

Zertifizierte Ladungssicherung
Certified load securing



Eloosafe Sicherungsklemme

Eloosafe safety clamp



Größen / Sizes



Klemmfunktion / clamp function

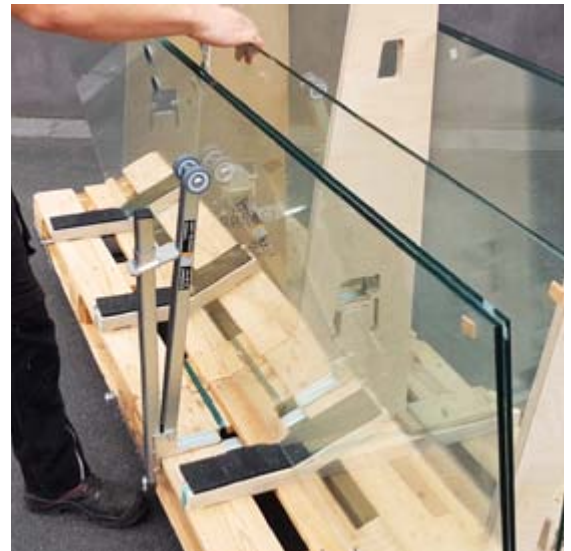

Blätterfunktion / leaf through function

Die Eloosafe Sicherungsklemme ist individuell an Paletten platzierbar. Einfach die beiden aufrechten Stangen auseinander drücken. Das Klemmeisen rutscht nach unten und drückt so die Rolle der beweglichen Stange an die aufrecht stehende Ware. Diese ist somit gegen ein Umfallen gesichert. Alternativ zur Rolle bieten wir eine Andruckplatte und ein durchgehendes Andruckprofil an.

The Eloosafe safety clamp can be placed individually on pallets. Simply push the two upright bars apart. The clamp iron slides down and presses the roll of the movable bar against the upright product. This prevents it from falling over. As an alternative to the roller, we offer a pressure plate and a full-length pressure profile.

Beamer Palettenheber

Beamer pallet lifting bar



Um Paletten sicher zu heben, gelten die Beamer Palettenhebeeisen von Eloorac als alternative Lösung zu Krangabeln. Besonders dann, wenn die Ware höher als die Krangabel ist. Der Palettenheber ist für sehr viele Palettentypen verwendbar, ist einfach zu verstauen und auf jeder Baustelle ein Standardwerkzeug.

In order to lift pallets safely, Eloorac beamer pallet lifting bars are an alternative solution to crane forks. Especially when the goods are higher than the crane fork. The pallet lifter can be used for many pallet types, is easy to store and a standard tool on any construction site.

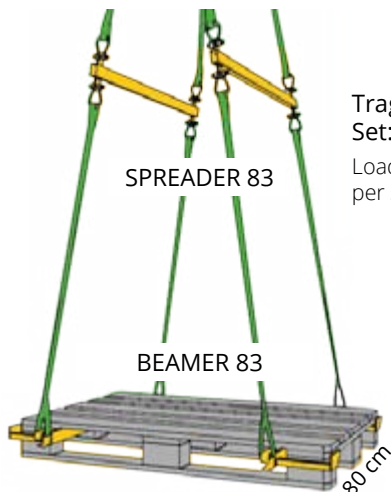

Tragkraft pro Set: 2.000 kg
Load capacity per set: 4410 lbs

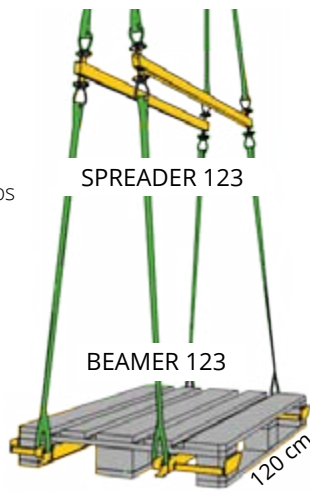

Ansteckbare Rollen für Paletten
Attachable castors for pallets

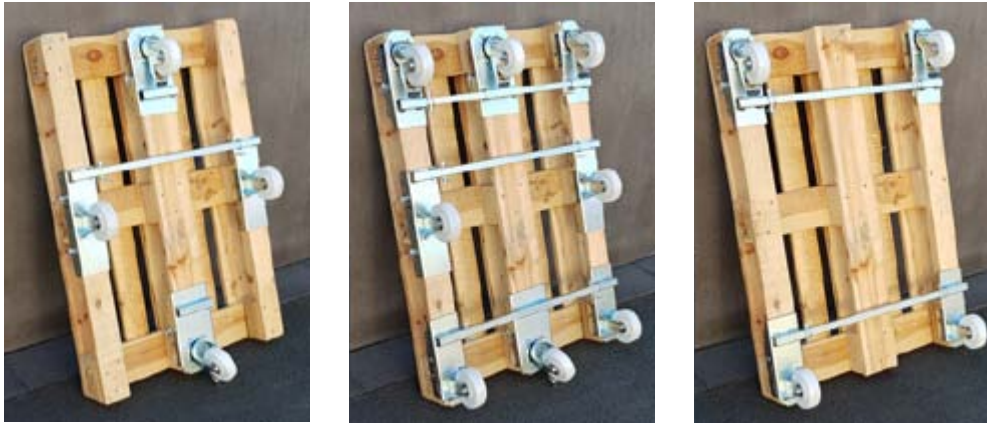

Durch das Eloowheel Rollensystem werden Paletten auf einfache Weise „mobil“. Ohne jegliche Werkzeuge können sehr schwere oder sehr lange Paletten rollbar gemacht werden.

Through the Eloowheel castor system, pallets get mobile in an easy way. Without any tools, heavyweight or very long pallets become rollable.



Eloowheels sind für Europaletten aus Holz und H1 Kunststoffpaletten konzipiert worden. Die Anwendungsbereiche sind daher sehr umfangreich.

Eloowheels are designed for wooden Euro pallets and H1 plastic pallets. The application areas are therefore very extensive.



Nicht nur einzelne Europaletten können mit Eloowheel Rollen rollbar gemacht werden. Das flexible Rollensystem bringt auch lange Paletten sowie Sonderpaletten in Bewegung.

Not only single Euro pallets can be made rollable with Eloowheel castors. The flexible roller system also makes long pallets and special pallets movable.



Alt.: PU

Eloowheel Details

Eloowheel details

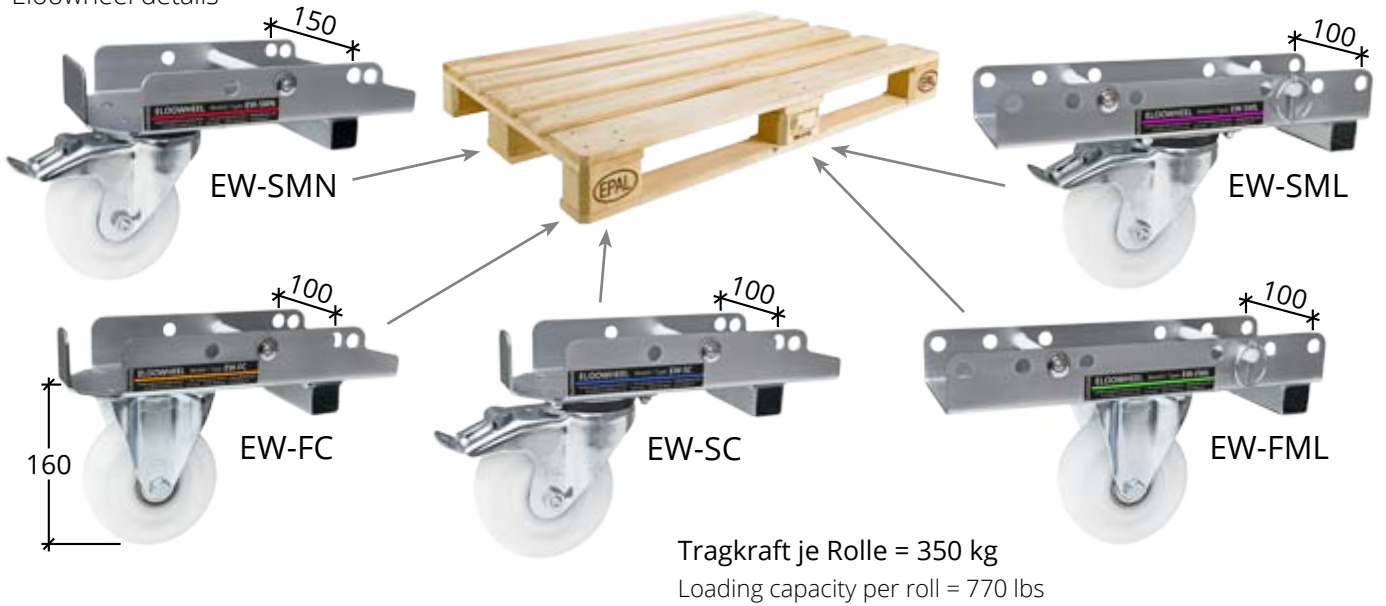

Legende: EW = Eloowheel

Legend: S = Swivel castor (Schwenkrolle / Lenkrolle)
F = Fixed castor (Feste Rolle / Bockrolle)
C = Corner of pallet (Ecke der Palette)

M = Middle of pallet (Mittig der Palette)
L = Long pallet site (Lange Paletten Seite)
N = Narrow pallet site (Kurze Paletten Seite)

Beispiel Sets für EURO Paletten

Example sets for EURO pallets

Rollen-Sets für 1 Palette längs / Castor sets for 1 pallets lengthwise



Rollen-Sets für 2 Paletten längs / Castor sets for 2 pallets lengthwise

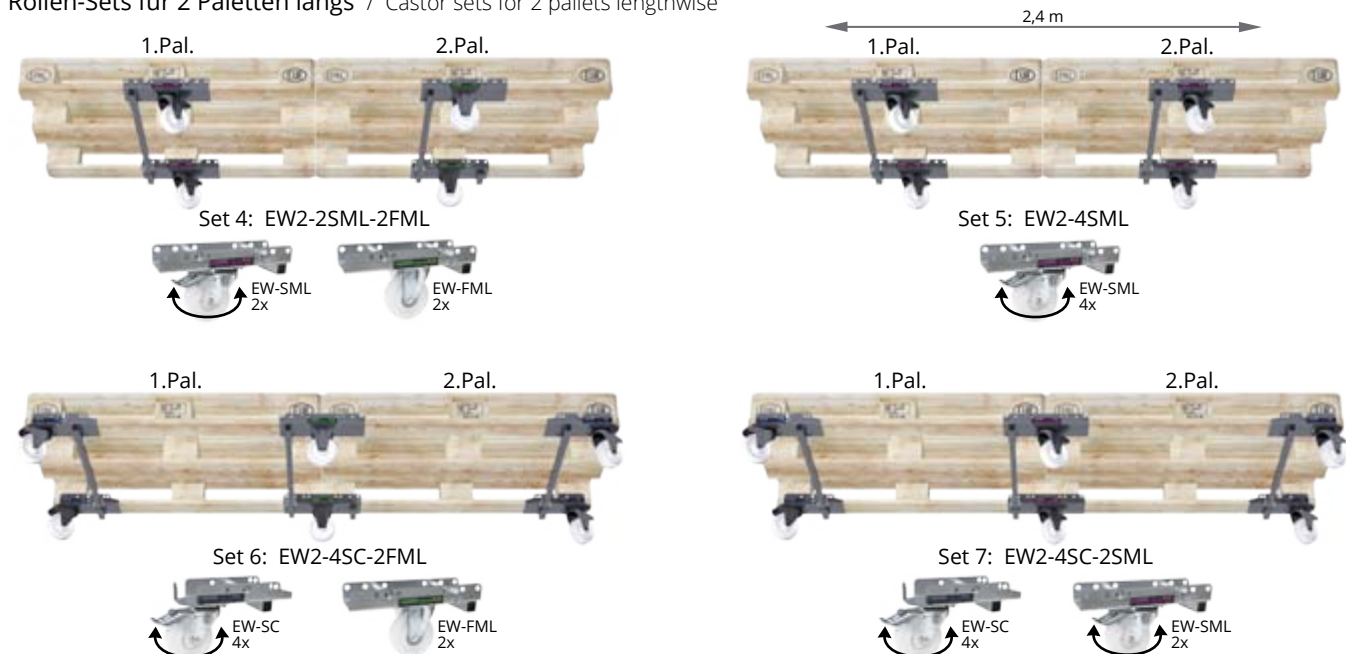

Rollen-Sets für 3 Paletten längs / Castor sets for 3 pallets lengthwise

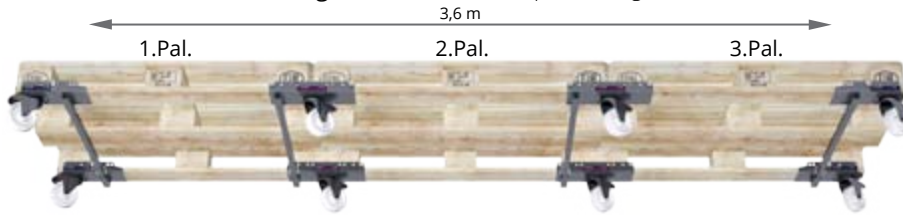

Set 8: EW3-4SC-4SML



Rollen-Sets für 4 Paletten längs / Castor sets for 4 pallets lengthwise

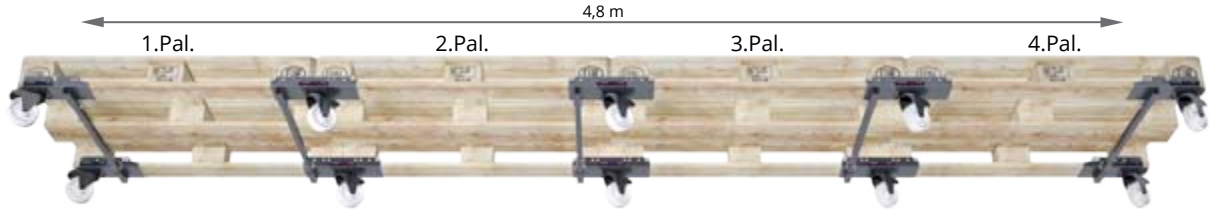

Set 9: EW4-4SC-6SML



Rollen-Sets für 2 + 3 Paletten quer / Castor sets for 2 + 3 pallets crosswise

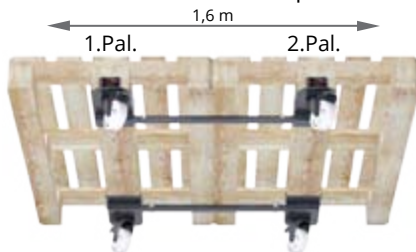

Set 10: EW2-4SMN

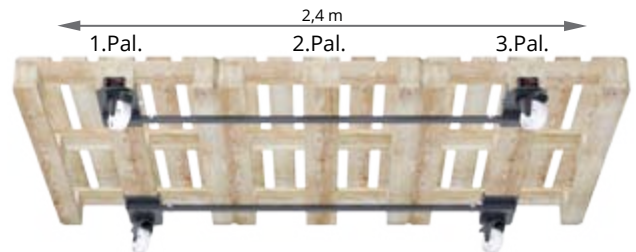

Set 11: EW3-4SMN

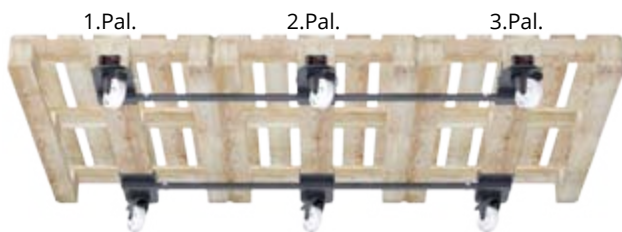

Set 12: EW3-6SMN

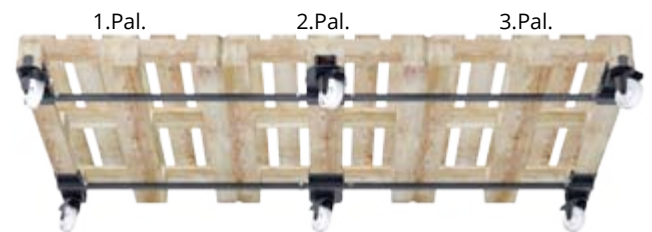

Set 13: EW3-4SC-2SMN



Lifter zum einseitigen Anheben einer Palette

Lifter for one-sided lifting of a pallet

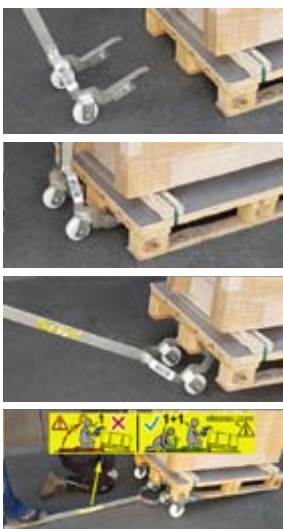

Der Lifter ist zerlegbar und hebt eine Palette einseitig um ca. 17 cm, so dass die 16 cm hohen Eloowheel Rollen montiert werden können.

The lifter is dismantlable and lifts a pallet on one side by approx. 17 cm, to be able to mount the 16 cm high Eloowheel castors.



Glas, Naturstein, Holzbranche
Glass, natural stone, wood industry



Beliebt sind die sehr variablen Eloorac Gestelle für kleinformatige Gläser. Auch die Lagerung im Hochregal beim verarbeitenden Kunden, ist ein Vorteil. Große Eloorac´s sind natürlich auch im Einsatz.

Popular are the very variable Eloorac frames for small format glasses. Also the storage in high rack at the processing customer is an advantage. Large Eloorac´s are of course also in use.



Um Plattenmaterialien lagern und bewegen zu können, kommen Elooracs vor allem in Tischlereien und Messebaubetrieben zum Einsatz. Die Möglichkeit jederzeit die passende Gestellgröße zusammen zu stellen, bringt enorme Flexibilität und somit einen hohen Grad an Effizienz.

To store and move board materials, Elooracs are primarily used in joineries and trade fair construction companies. The possibility to put together the right frame size at any time, brings enormous flexibility and thus a high degree of efficiency.



Fenster, Haustüren, Zäune
Windows, front doors, fences



Eloorac´s sind als Fenstertransportgestell die Alternative zu herkömmlichen Metallgestellen. Der große Vorteil liegt in der einfachen Rückführung der leeren, zerlegten Gestelle.

Eloorac´s are the alternative to conventional metal racks for window transport. The big advantage is the easy return of the empty, dismantled racks.



Größere und oft auch schwerere Produkte werden mit dem Eloorac System bewegt.

Larger and often also heavier products will be moved with the Eloorac system.



Geprüfte Stabilität

Tested stability

Eloorac Gestelle wurden vom VDZ Prüfzentrum in Dortmund umfangreich getestet. Unter anderem konnte man den seitlich aushaltbaren Druck einer einzelnen Wange ermitteln bzw. festlegen. Dies geschah durch die gezielte Überbeanspruchung eines an einer Palette befestigten Eloorac A-Teils, welches in einer Druckvorrichtung praktisch zerstört wurde.

Eloorac racks have been extensively tested by the VDZ test centre in Dortmund/Germany. Among other things, it was possible to measure or determine the sideways pressure of a single frame. This was done by overstressing an Eloorac A-part attached to a pallet, which was practically destroyed in a pressure device.

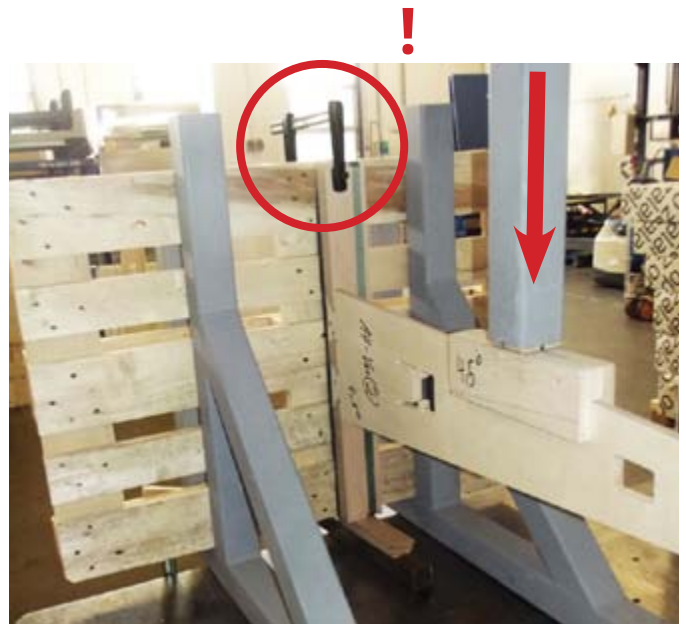

Tragfähigkeiten der Eloorac Modelle

Load capacities of Eloorac models

Die hier angegebenen Werte sind ermittelte Ergebnisse des oben beschriebenen Tests und beziehen sich immer auf:

EIN EINZELNES AUFRECHTES WANGENTEIL.

Um den Wert für ein Set zu ermitteln, muss einfach mal 2 gerechnet werden! Alle Angaben sind mit mindestens 2-facher Sicherheit gerechnet.

The indicated values are determined results of the test described above and always refer to:

ONE SINGLE UPRIGHT A-PART.

In order to determine the value for a set, you simply have to calculate 2 times! All values are calculated with at least 2-fold certainty.

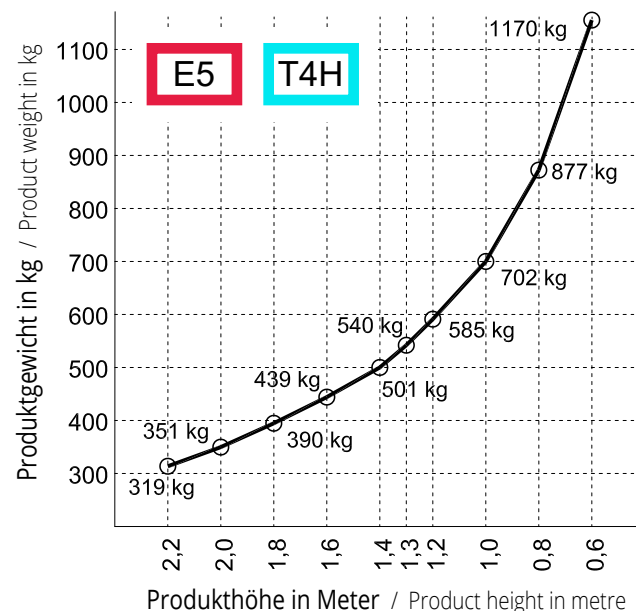
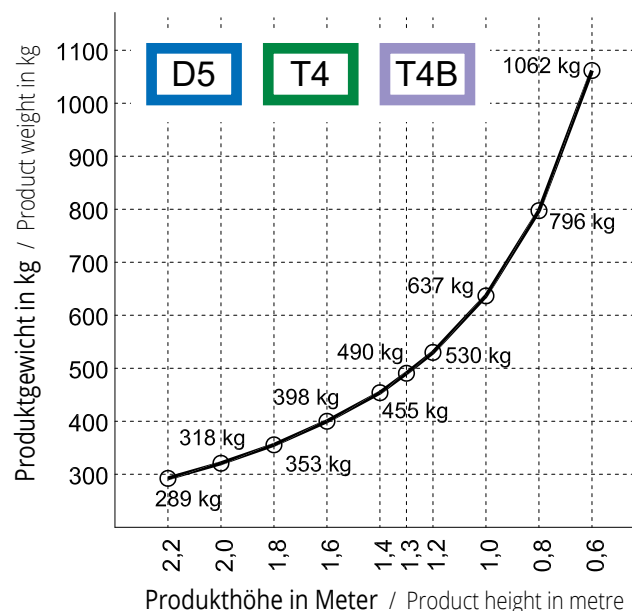
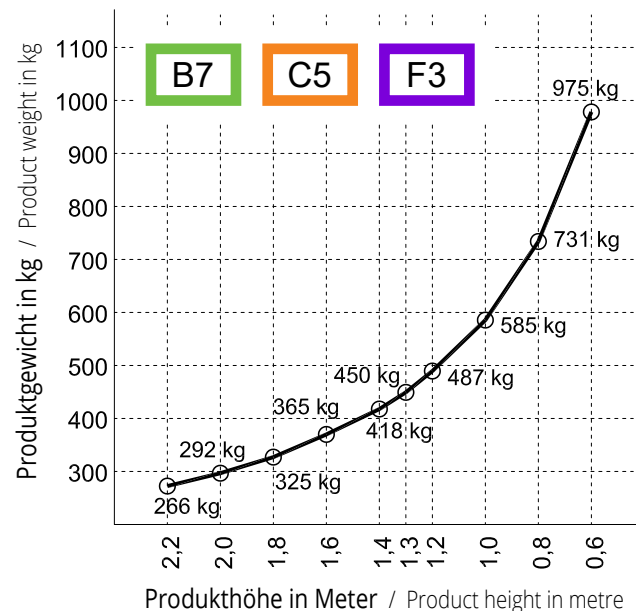

Kurze Lieferzeiten / Short delivery times



Das Eloorac Lager ist so konzipiert, dass jede Gestell-Kombination schnell geliefert werden kann.
The Eloorac warehouse is designed in such a way that any rack combination can be delivered quickly.

Fakten zum ELOORAC Transportsystem kurz zusammengefasst:
ELOORAC Transportsysteme...

- wurden schon X-Mal wiederverwendet
- sind nach Normen getestet und zertifiziert
- bestehen aus wasserfest verleimtem Sperrholz
- sind nicht kennzeichnungspflichtig (Export)
- sind mit einem Sicherheitsfaktor von über 2,0 getestet
- können mit dem Palettenheber „BEAMER“ gekrant werden
- besitzen eine hohe Kippsicherheit
- werden durch „ELOWHEEL“ Transportrollen mobil (350 kg/Rolle)
- können mit dem Stapler oder einem Hubwagen bewegt werden
- werden auf Wunsch mit gummierter Auflagefläche geliefert
- sind auf Europaletten oder Sonderpaletten montierbar



Facts about the ELOORAC transport system in a short summary:
Eloorac transportsystems...

- have already been reused X times
- are tested and certified according to standards
- consist of waterproof glued plywood
- are not subject to labelling (export)
- are tested with a safety factor of over 2.0
- can be lifted with the „BEAMER“ pallet lifter
- have a high tilt resistance
- are made mobile by „ELOWHEEL“ transport rollers (770 lbs/roll)
- can be moved with a fork-lift truck or a hand pallet truck
- can be supplied with rubberized support surface on request
- to be mounted on Euro pallets or special pallets

